

Operational & Service Manual

10,000lb - 16,000lb Axles



SAFETY NOTICE	4
NEW AXLE SETUP	4
MAINTENANCE SCHEDULE	4
BEFORE EACH USE	4
3 MONTHS OR 3,000 MILES	4
6 MONTHS OR 6,000 MILES	4
12 MONTHS OR 12,000 MILES	4
AXLE IDENTIFICATION	5
STANDARD LABEL	5
SERIAL LABEL	5
LOADING AND APPLICATION	6
LEVELNESS & DISTRIBUTION	6
TORSION AXLES	6
WEIGH IN	7
THIS POSITION 2 SHOWS HOW TO DETERMINE THE LOAD ON EACH AXLE.	7
TRAILER ELECTRICAL	8
BRAKE SYNCHRONIZATION	9
WIRING SCHEMATIC 7 WAY	10
ELECTRIC BRAKES	11
THEORY OF OPERATION	11
BRAKE SPECIFICATIONS	11
BRAKE SHOE INSPECTION	12
DISC BRAKES	13
THEORY OF OPERATION	13
BRAKE SETUP AND USE	14
HUBS & DRUMS	15
DRUM IDENTIFICATION	15
DRUM INSPECTION	15
BEARINGS	16

BEARING MAINTENANCE	16
HUB REMOVAL	16
SEAL REMOVAL & INSTALLATION	16
BEARING INSPECTION	16
RACE (BEARING CUP) REMOVAL & INSTALLATION	17
BEARING INSPECTION	17
BEARING INSTALLATION & ADJUSTMENT	17
LUBRICATION	17
<hr/>	
OIL	18
GREASE	18
GREASE PACKING BEARINGS	18
SUSPENSIONS	18
<hr/>	
AIR RIDE AXLES & OTHER TYPES.	18
SLIPPER SPRINGS	18
TORSION EQUALIZER AXLES	18
INSPECTION & REPLACEMENT	19
SPRING REPLACEMENT	19
EQUALIZER REPLACEMENT	19
WHEELS & TIRES	20
<hr/>	
STORAGE & INFREQUENT USE	21
<hr/>	
STORAGE PREPARATION	21
AFTER STORAGE	21
TORQUE REQUIREMENTS	22
<hr/>	
OIL & GREASE SPECIFICATIONS	22
<hr/>	
GREASE	22
OIL	23
PARTS LISTS	23
<hr/>	
10K	23
12K	24
16K	25
TROUBLESHOOTING	26
<hr/>	
BRAKING	26
HUBS & BEARINGS	29

SUSPENSION	30
SALES & SERVICE	31
TECHNICAL SUPPORT	32
WARRANTY	32
NOTES:	33

Safety Notice

Providing safe dependable operation of your axle(s) and related components is important. This manual provides basic procedures for service and repair using established industry standards and techniques. There are many variations in procedures to repair and maintain your axle(s) and its related parts; however, it is not possible to provide you with all the details for various service procedures. Refer to your trailer manufacturers' owners manual for any specific warnings and procedures that may relate to the safety and maintenance of your trailer. If these procedures are not clear to you or if you are unsure of how to proceed you should contact a trailer repair facility who has a trained axle repair technician for advice or repair.

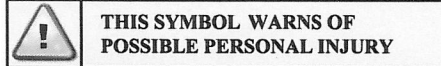

**THIS SYMBOL WARNS OF
POSSIBLE PERSONAL INJURY**

**This symbol indicates a torque
requirement, please see page 22.**



New axle setup

Lug Nut Torque	Re-torque lug nuts on new trailers at 25, 50 miles. See pages 20 and 21 for torque requirements and techniques
Brake Adjustment	All 10K, 12K, and 16K brakes are self adjusting. The brakes will automatically adjust as needed regardless of direction of travel.
Tire pressure	See tire manufacturer's recommendations
Brake Synchronization	Refer to Brake Controller manufacturer's recommendations.

Maintenance Schedule

Lug nuts should be checked periodically after initial setup period.

Before Each Use

- Test that brakes are functional
- Check battery charge and switch operation of breakaway systems.
- Check that tire inflation meets VIN pressure.

3 Months or 3,000 Miles

- Wheels should be checked for cracks, dents, or other distortions.

6 Months or 6,000 Miles

- Brake magnets should be checked for wear and current draw.
- Brake controller should be checked for correct modulation and amperage.
- Suspension parts such as the springs, equalizers, hangers, and fasteners should be checked for bending, loosening, and excessive wear.

12 Months or 12,000 Miles

- Brake linings should be checked for wear and contamination.
- Brake cylinders (hydraulic) should be checked for fluid leaks or sticking.
- Brake lines (hydraulic) should be checked for and cracks, leaks, or kinks.
- Wiring should be checked for bare spots, fraying, etc.
- Drums should be checked for abnormal scoring and excessive wear.
- Wheel bearings and races should be checked for corrosion and wear.
- Seals should be checked for leakage.
- Springs should be checked for wear and loss of arch.
- Welds should be inspected on the hangers.

Axle Identification

Rockwell American offers many different combinations and capacities of axles. In order to identify your axles you will need to locate the axle identification label on your axle beam. The labels will appear similar to the one below.

Standard Label

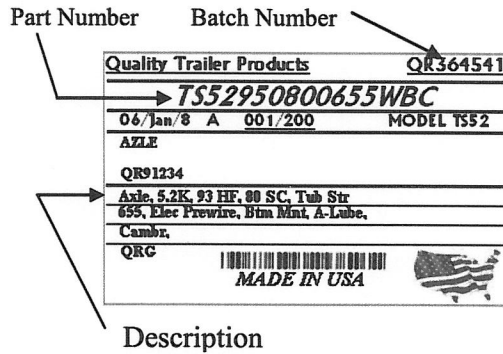

The standard axle label can found on most axle assemblies and beams. With this information your axle can easily be identified by any of our distribution locations or technical support. Basic specifications can be determined by the three line short description.

Serial Label

In addition to a standard label DOT requires that all axles rated at 10,000 lbs and above have a serialized identification label on them. There are two styles of serial labels. The newer style is shown below. It is a 3x2 adhesive tag.

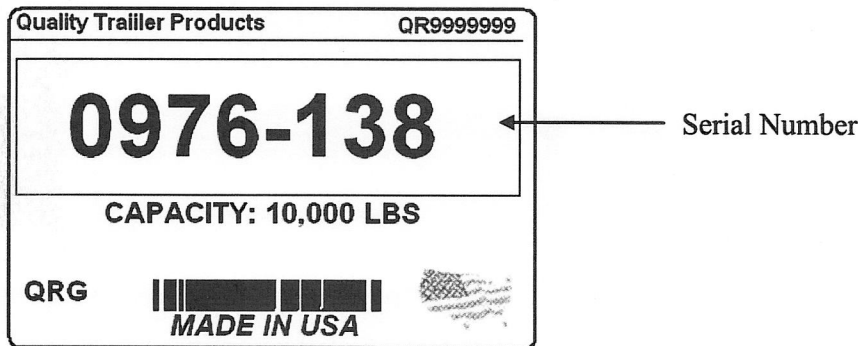

The second, older style is a 3x1 metal plate that is riveted onto the axle.

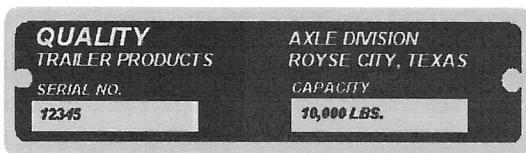

Serial number information will be required for all warranties.

Loading and Application

GAWR vs. GVWR

An easy way to determine the carrying capacity of your axles is to locate the Vehicle Identification Number tag on your trailer. It would appear similar to the one below.

MANUFACTURER <input type="text"/>			
DATE <input type="text"/>			
GAWR FRONT	WITH TIRES	RIMS AT	COLD
<input type="text"/>	<input type="text"/>	<input type="text"/>	<input type="text"/>
GAWR REAR	WITH TIRES	RIMS AT	COLD
<input type="text"/>	<input type="text"/>	<input type="text"/>	<input type="text"/>
THIS VEHICLE CONFORMS TO ALL APPLICABLE FEDERAL MOTOR SAFETY STANDARDS IN EFFECT ON THE DATE OF MANUFACTURE SHOWN ABOVE.			
VIN <input type="text"/>			

Often the VIN tag will list each axle's rated capacity separate. The capacity will be listed as the GAWR (Gross Axle Weight Rating). The total capacity of the trailer is will be listed as the Gross Vehicle Weight Rating (GVWR). Often this will include the "tongue weight" and therefore cannot be relied upon to determine the axle capacity.

Levelness & Distribution

It is important when towing the trailer that several factors are taken into account. The first is the levelness of the trailer. The trailer should be level to the ground. If the hitch is too high or too low one axle will be given more of the load and the overall center of gravity will be changed. Failure to properly level the trailer can result in anything from poor braking performance, pre-mature tire wear, to decreased bearing life. See the illustration.

Incorrect-Low Front

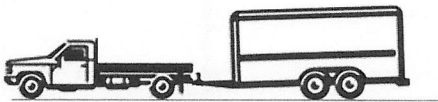

Correct-Level

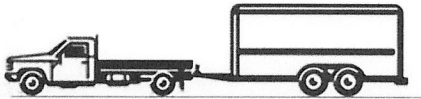

Incorrect-High Front

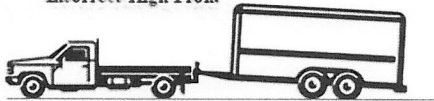

The distribution of the load on the trailer is also a factor. If one axle carries a load higher than its rate GAWR, that axle will be more likely to suffer from tire wear and bearing problems. It cannot be assumed that if the load is less than the GVWR that an axle will not be overloaded.

Note:

When loading the trailer it is important that the weight being placed on the axle does not exceed that axle's rated capacity. This is important on rear loading trailers where the back axle may briefly carry the entire load.



Example:

A tandem trailer with two 10,000 lb rated axles being loaded with a 12,000 lb piece of machinery may exceed the rating of the rear axle.

Torsion axles

Torsion axles have independent suspensions. The loading of the trailer as well as the road conditions can be factors in the lifespan of the axle and its components. Severely uneven terrain such as those found in mining, oil fields, and exploration sites can cause severe shock loads and overload situations capable of bending the axle's spindle, and causing bearing failure. It is important for the life of the axle that the load be evenly distributed and that all tires maintain contact with the ground while the trailer is loaded.

Weigh in

The best way to verify that a given load is properly distributed as well as ensure that the GAWR has not been exceeded is to weigh the trailer at a truck scale. The Position 1 below shows how to determine the combined axle load.

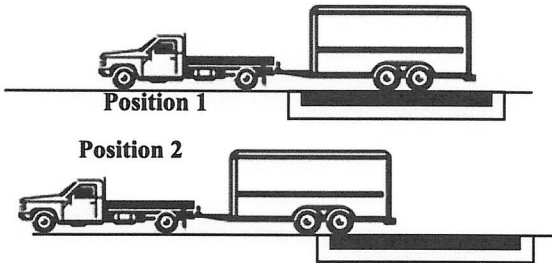

This Position 2 shows how to determine the load on each axle. The rear axle's load will be provided on the weigh slip for Position 2. The front axle's can be determined by subtracting the combined load from the rear axle load.

$$\text{Front Axle} = \text{AxleWeight}(\text{Position1}) - \text{AxleWeight}(\text{Position2})$$

$$\text{Rear Axle} = \text{AxleWeight}(\text{Position2})$$

This method can be slightly modified to determine the distribution and weight on tri-axle assemblies. As shown below.

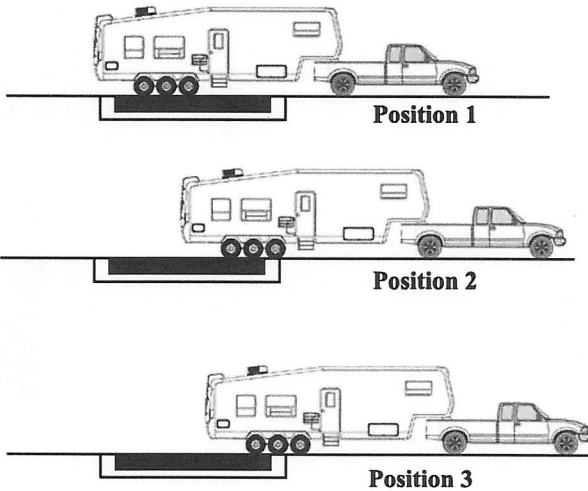

$$\text{Front Axle} = \text{AxleWeight}(\text{Position1}) - \text{AxleWeight}(\text{Position2})$$

$$\text{Mid Axle} = \text{AxleWeight}(\text{position2}) - \text{AxleWeight}(\text{position3})$$

$$\text{Rear Axle} = \text{AxleWeight}(\text{Position3})$$

Trailer Electrical

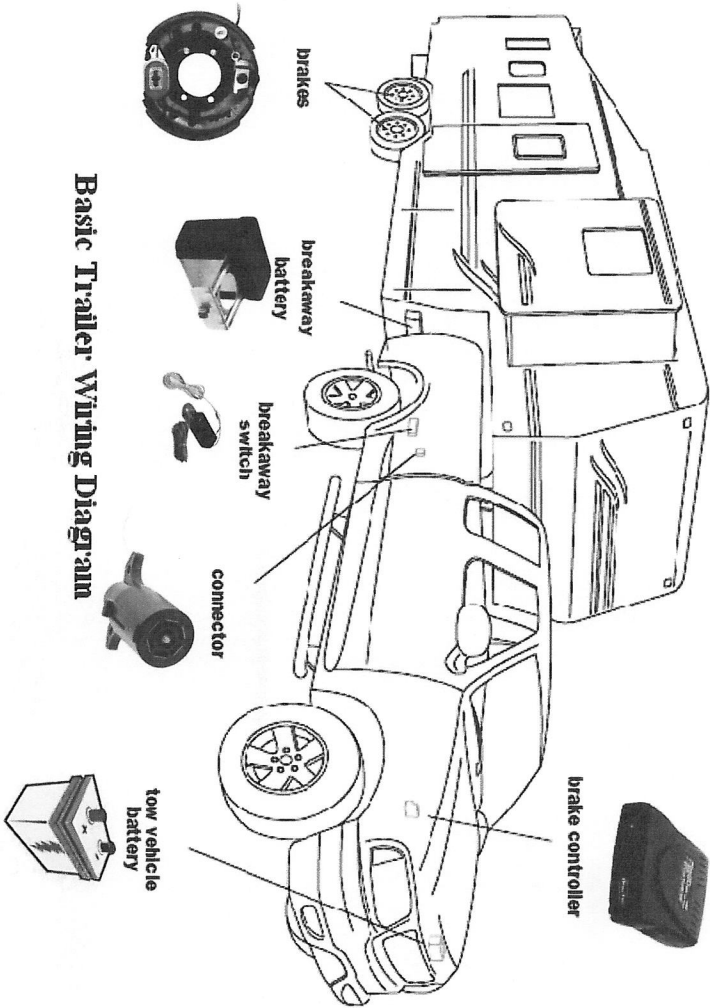

Basic Trailer Wiring Diagram

If equipped with electric brakes, the diagrams below will be helpful in determining the type of connector installed on the trailer as well as a schematic of the pin connections. Detailed schematic is shown on page 10.

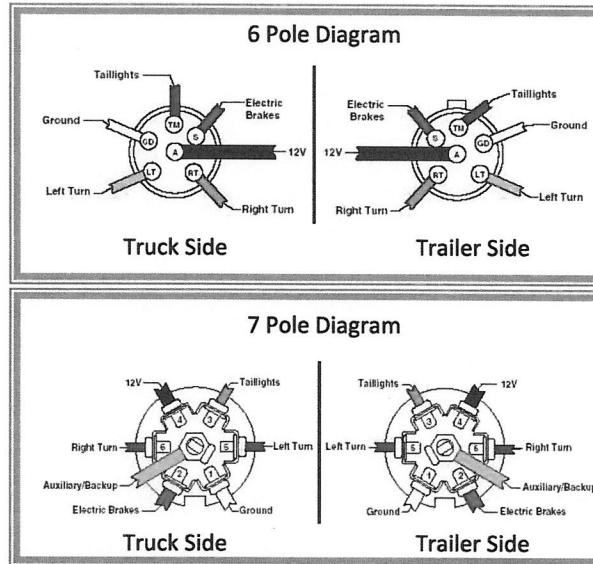

These diagrams represent the most common configurations found on trailers with electric brakes. 4 and 5 way trailer connections are not normally used on trailers with electric brakes. These configurations do not have a dedicated brake wire.

Wiring gage is also important when using a trailer with electrical brakes. Use of the improper gage of wire can result in decreased brake performance.

Number of Brakes	Trailer Hitch to Axle	Minimum Wire size
2	All Lengths	12 AWG
4	Less than 30 feet	12 AWG
4	30-50 feet	10 AWG
6	Less than 30 feet	10 AWG
6	30-50 feet	8 AWG

Brake Synchronization

It is important to ensure that the trailer brakes are properly synchronized to the tow vehicle brakes. This is necessary for the brakes to operate as designed as well as prevent pre-mature wear of the brake components.

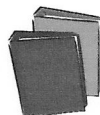

Refer to Brake Controller manual provided by the installer for procedure and operation of the controller

Wiring Schematic 7 Way

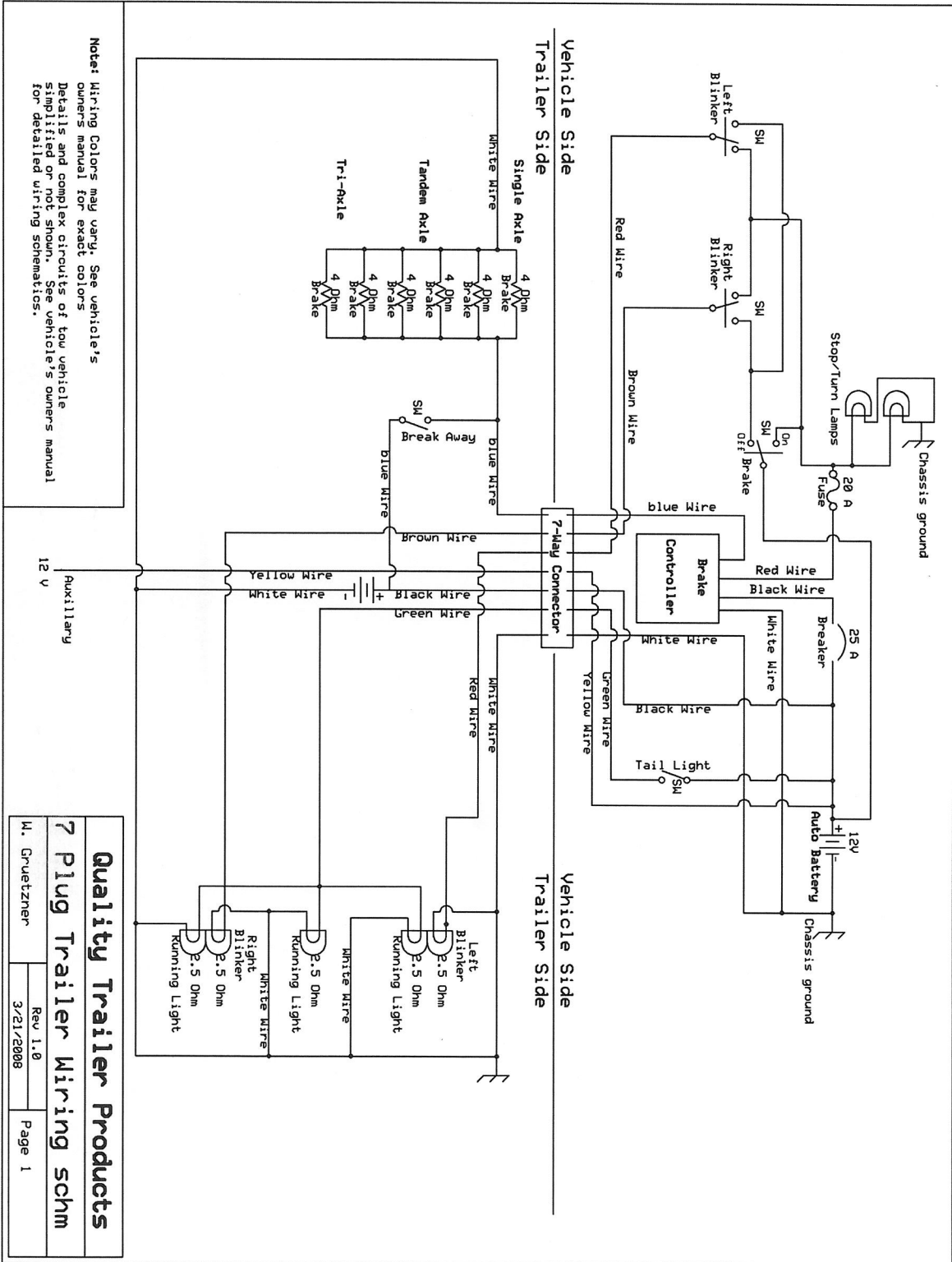

Quality Trailer Products

7 Plug Trailer Wiring schem

W. Gruetzner Rev 1.0 Page 1

3/21/2008

Electric Brakes

If equipped, your trailer's electric brakes are actuated by an electromagnet which is controlled by the electrical impulses from the brake controller. The trailer brakes will apply smoothly and slightly ahead of the truck brakes if all the brake components are installed and connected properly.

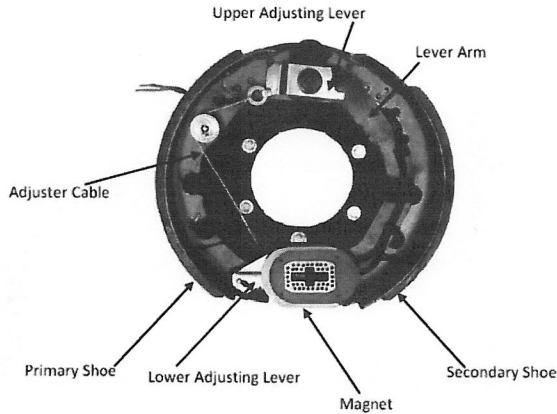

Right hand 10K brake Shown

Theory of Operation

When electrical current is sent to the magnets the activated magnet will contact the rotating armature surface of the brake drum. This contact moves the actuating arm against the cam above the anchor pin.

This forces the primary shoe to engage. Pressure from the primary shoe will be transmitted through the adjuster linkage and engages the secondary shoe. As brake pressure (applied by the driver) is increased,

the electrical flow to the magnets increases the pressure between the brake linings and drum. As the linings wear the brake will automatically adjust to the proper setting.

Brake Specifications

Brake	Pri. Lining Code	Sec. Lining	Amperage
12.25x3.5	GG	GG	3.2-3.5
12.25x5	GG	GG	3.2-3.5

Note: Specifications subject to change without notice. Linings are Semi-Metallic.

The GG lining code used on your brakes provides both a static and dynamic coefficient of friction of 0.5. This friction is 20% higher than the common FF linings therefore your brakes will provide superior stopping power, but also generate more heat.

The amperages listed above are measured at 12 volts DC. Your amperage may be measured by using the formula:

$$\text{Amperage} \cong \frac{\text{Voltage}_{(\text{at magnet})}}{4}$$

Both outside temperature and use can affect the amperage. Under constant load the amperage will decrease slightly. This is not uncommon and it should return to normal after cooling.

Brake Installation

All electric brakes should be installed using Grade 8 bolts. I. The OEM bolt torque specifications are shown on page 22.



Note: when installing brakes the magnet wire should always be to the rear of the axle.

Once the brake is bolted to the axle the wires should be connected using butt connectors. There is no polarity so either wire can be connected to the ground wire.

Brake Shoe Inspection

Periodic inspections of the brake shoes should be done to check for wear. This preventative check will help to prevent further damage to the brake system. When working with brake shoes wear appropriate breathing protection to avoid inhaling the brake dust.

- A normal wear pattern is for the rear pad to be slightly more worn than the front pad. Additionally the brake should appear to have more wear near the middle of the shoes.
- Some heat cracking in the pads is normal. And is not a cause for concern.

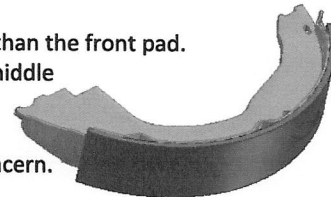

Acceptable Cracks

If the brake shoes are glazed in appearance, they may be roughed up by using a wire brush and rough grit sand paper.

Brake shoes should be replaced if:

- The pads are oily or soaked in grease
- Less than $\frac{1}{16}$ th of lining remaining.
- The shoe (metal portion) itself appears to be bend or worn.
- The linings should be inspected for any evidence of separation from the shoe backing.
- There are deep gouges or grooves cut into the pad material.

Brake shoes should always be replaced in pairs. This will help ensure that the braking system is uniform. After a shoe replacement repeat the burnish process as indicated on page 14.

Replacement Shoe Kits	
Brake Size	Shoe Kit Part Number
12.25x3.5	4738-2(Left)/3 (Right)
12.25x5	4741-2(Left)/3 (Right)

Magnet Inspection

Periodic inspections of the brake magnet should be done to check for abnormal wear or damage. This preventative check will help to prevent further damage to the brake system. A straight edge will aid in this inspection.

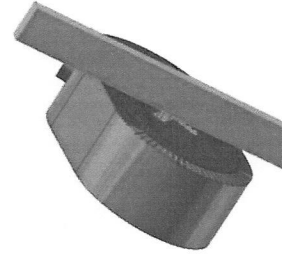

Normal Wear

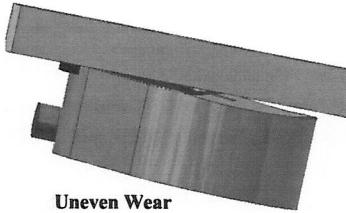

Uneven Wear

If any of the coils are visible replacement of the magnet is required. In addition to the visual inspection it is recommended to check the current draw of the magnets as well. Amperage ranges are listed on page 11.

Replacement Magnet Kits	
Brake Size	Magnet Kit
12.25x3.5	4738-23
12.25x5	4738-23

Disc Brakes

If equipped with electric over hydraulic disc brakes, your brakes are actuated by hydraulic fluid line pressure provided by the hydraulic actuating unit. This unit is controlled by the electrical impulses from the brake controller. The trailer brakes will apply smoothly and slightly ahead of the truck brakes if all the brake components are installed and connected properly.

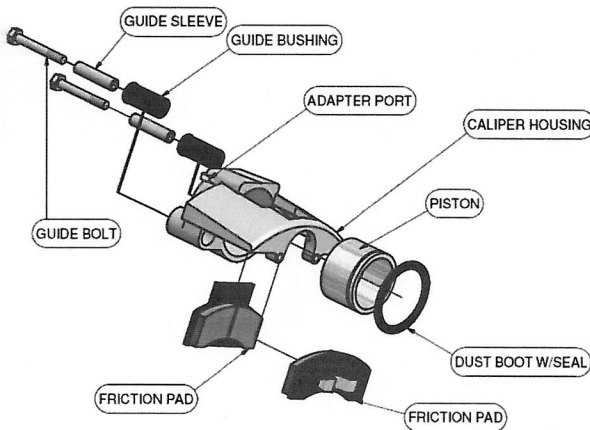

Theory of Operation

Rockwell American axles with disc brakes utilize a floating caliper design. When the actuating unit provides pressure to the piston, the piston forces the inner friction pad against the rotor surfaces (rotor not shown for clarity). As the pressure builds the caliper will slide along the guide bolts and cause the outer friction pad to also contact the rotor. This clamping pressure forces the rotor to stop turning. It is important that the actuating unit and brake controller be rated for the disc brake application.

For more information on disc brakes visit www.Kodiaktrailer.com



DOUBLE CHECK

- Make sure your controller is installed according to the manufacturer's recommendations
- Make sure that the proper brake controller adjustments have been made to correctly engage the tow vehicle brakes and the trailer brakes to work together providing safe and comfortable braking.
- Make sure the trailer brakes are grounded properly to the tow vehicle.

Brake Setup and Use

Burnishing-Burnishing is necessary to ensure proper seating and wear in of the brake components.



Burnishing is accomplished by applying the trailer brakes to reduce the vehicle speed by 20 mph 20-30 times. For example: reduce speed from 40 mph to 20 mph. Allow ample time between burnish snubs to allow brake to cool and prevent glazing. This should be done in a low traffic area for safety.

Adjustment-the OEM Electric brakes standard on our 10,000 lb capacity and above axles are self adjusting. If the adjuster is not functioning as desired, adjusting the brakes manually is an option.

This can be done by turning the star on the brake adjuster.



FAILURE TO PROPERLY LIFT AND SECURE TRAILER MAY CAUSE PERSONAL INJURY OR DEATH.

- 1) Lift trailer and secure on jack stands. Please follow the trailer manufacturer's guidelines on lifting locations.
- 2) Remove the rubber plugs behind the adjuster wheel.
- 3) Using a flat headed screw driver press the lower adjuster lever outward so that it will not prevent adjustment.
- 4) Using a brake spoon or screwdriver adjust the brakes so that they expand and the wheel no longer spins.
- 5) Adjust the brakes inward so that a slight drag is present.
- 6) Repeat on remaining wheels and lower trailer.

Hubs & Drums

Drum Identification

Axle hubs are generally broken down into categories based on axle capacity and hub pilot. There are two different hubs available on 10,000lb and 12000 lb axles

Available Hubs		
Capacity	Available wheel Pilots	Bolt Circle
10K	4.75"	8 on 6.5"
10K	4.88"	8 on 6.5"
12K	4.75"	8 on 6.5"
12K	4.88"	8 on 6.5"

An additional two combinations are solely available on 16,000 lb capacity axles. Since each of these hubs has a different profile, they are not interchangeable on the axle. You cannot convert from one bolt pattern to the other

Available Hubs		
Capacity	Available wheel Pilots	Bolt Circle
16K	221 mm	8 on 275mm
16K	6.50"	10 on 8.75"



FAILURE TO USE THE PROPER WHEEL PILOT CAN RESULT IN WHEEL SEPERATION AND PERSONAL INJURY OR DEATH.

Drum Inspection

Periodic drum inspection should be done to check for wear. The two surfaces that are to be checked are the brake shoe contact area and the armature surface of the drum. These surfaces should be checked for uneven/excessive wear and abnormal scoring or gouging.



For the shoe contact area, if any drum is worn more than 0.020" oversized or 0.015" out of round (measured as total indicator run-out), the drum should be resurfaced. If the drum has worn to a diameter of more than 12.340" or after resurfacing would be more than 12.340" the drum would need to be replaced.



The armature surface (magnet contact area) needs to be resurfaced if the worn unevenly. Do not remove more than 0.030" from this surface. After resurfacing the surface finish should be no more than 120 micro inches. If the armature surface is refinished the magnets must also be replaced to prevent further damage. On 10,000 axles the armature surface is separate from the drum and can be replaced.

- Inspect and clean hub cavity to ensure all metal shavings have been removed.

Bearings

Rockwell American uses industry standard tapered roller bearings in our axles. The use of tapered roller bearings, as opposed to ball bearings, helps reduce axial endplay and is essential to good performance and long bearing life.

Bearing Maintenance

Axle bearings should be checked periodically to extend bearing life. This will also help catch major problems before they happen. In order to check the bearings the hub/drum must be removed. Simply injecting more grease or oil into the axle will not prevent all problems.

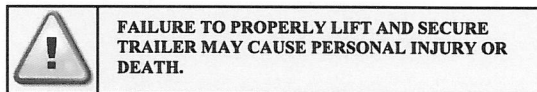

Hub Removal

1. Lift trailer and secure on jack stands. Please follow the trailer manufacturer's guidelines on lifting locations.
2. After securing and lifting the trailer remove the wheels.
3. Remove the plastic oil cap using the appropriate socket, pliers, or wrench.
4. Remove the cotter pin.
5. Remove the spindle nut using a 2 ¼ socket (10,000 lb axles) or a 2 ½ socket (12,000lb-16,000lb axles).
6. Remove spindle washer
7. Using a hub puller remove the hub from the axle. (The seal may make removal difficult otherwise) The seal may separate.

Seal Removal & Installation

The seal must be replaced after each removal to prevent failure.

1. Pry the seal out of the hub using a screwdriver. Take care to avoid scratching the sealing surface of the hub or the inner bearing.
2. If the inner rubber portion of the seal remains on the spindle pry off using pliers. Take care not to scratch or damage the spindle. Crocus cloth may be used to polish spindle if necessary.
3. Tap the seal into place using a wood block or seal installation tool.
4. DO NOT use sealant on seal surfaces.

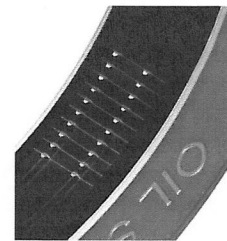

Bearing Inspection

Cleaning the bearings thoroughly will make inspection easier. Use a lint free cloth to dry.

1. Inspect inner ring for wear, corrosion, or excessive heat.
2. Inspect individual rollers by rolling in hand for pitting, spalling, or corrosion. Do not spin using compressed air

3. Check cage for cracks or other damage.
4. If any of the above damage is found the replace bearing and corresponding race.

Race (bearing cup) Removal & Installation

It is important that bearings and races be replaced in pairs to avoid pre-mature failure.

1. Place the hub on a flat surface with the race to be removed facing downward.
2. Using a soft brass punch tap around the top surface of the race until the race is dislodged, taking care not to damage other surfaces.
3. Clean hub thoroughly to ensure that no metallic flakes or lint is left inside the hub.
4. Install the new race by tapping in with a soft brass punch. Verify that the race is seated fully in the hub.

Bearing Inspection

1. Inspect raceway for wear, corrosion, or excessive heat.
2. If any damage is found replace the race and corresponding bearing.

Bearing Installation & Adjustment

Once the components have been replaced the following procedures must be done to complete installation. If your hubs are grease packed, repack prior to installation. See page 18.



FAILURE TO PROPERLY INSTALL THE SPINDLE NUT CAN RESULT IN WHEEL SEPERATION AND PERSONAL INJURY OR DEATH.

1. Install hub onto axle once inner bearing and seals have been installed. Take care not to damage the inner seal on the threads
2. Install the outer bearing by sliding it over the spindle.
3. Install the spindle washer.
4. Start the spindle nut by hand
5. Tighten the spindle nut using a 2 ¼ socket (10,000 lb axles) or a 2 ⅝ socket (12,000lb-16,000lb axles).
6. Using a torque wrench torque the spindle nut to 100 ft-lbs.
7. Back the spindle nut off ¼ of a turn and align the cotter pin hole with the spindle nut.
8. Insert the cotter pin.
9. Tighten the plastic oil cap to 30 ft-lbs.
10. Refill with oil (if equipped).
11. Re-install wheels per instructions on page 20 and 21.



Lubrication

Rockwell American offers two types of bearing lubrication on these assemblies. In addition to checking during bearing inspection and replacement it is important to routinely check the lubrication in your hubs

Oil

If equipped with oil bath hubs (clear caps) the oil level should reach the fill line on the cap after the trailer has been stationary and the oil has pooled. Overfilling the hub does not provide extra protection. Oil may be added by removing the rubber plug.

It is recommended that only high quality non-synthetic SAE 80-90w gear oil be used to refill oil bath axles. The OEM oil is red in color to aid in visibility. See page 23 for oil specifications and recommended sources.

Grease

If equipped with greased hubs (blue caps) the condition of the grease should be checked to ensure proper bearing life.

It is recommended that only high quality NLGI 2 grease be used to repack bearings. See page 22 for grease specifications and recommended sources.

Grease Packing Bearings

Hand pack each bearing by hand or use a bearing packing tool. To pack by hand do as follows:

1. Place grease into the palm of your hand.
2. Press and work grease in between the individual rollers. This is done more easily by forcing through at the widest side of the bearing.
3. Repeat for each roller taking care to rotate the bearing as this is being done. The entire bearing should be full of grease.
4. Liberally coat the race (bearing cup) with grease.

Suspensions

With most axles of these capacities Quality also provides the suspension system as well as the axle. These components are designed to perform a number of tasks and to provide your trailer with the best and smoothest towing possible. Not all types of suspension are available on all axles.

Air Ride Axles & Other Types.

Please refer to the trailer manufacturer for details.

Slipper Springs

The most common type of undercarriage is the slipper spring configuration. These axles are installed in single, tandem, spread, or triple configurations. Slipper springs have an eye only at one end which contains a rubber bushing to aid in wear. The trailing end of the spring is designed to slide against the rear hanger.

Torsion Equalizer Axles

Your trailer may be equipped with our Equalizer axles. These axles rely on a rubber suspension with superior dampening characteristics to provide a smooth reliable ride. They are designed to meet

individual customer requirements. This is a self contained system and should not be modified. These axles should be bolted to the frame using the brackets. Secondary attaching brackets are provided per customer request.

Inspection & Replacement

It is important to periodically check the suspension components of the slipper spring axles to ensure that they are not worn. Any components with excessive wear or damage should be replaced.

Front of Trailer

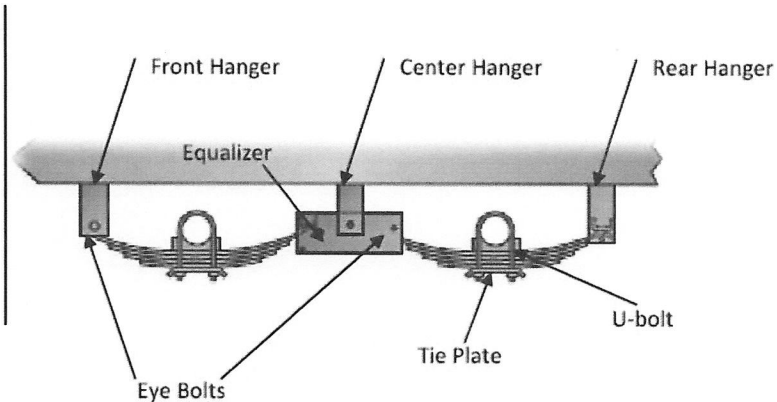

Spring Replacement

To remove the springs or any spring component please refer to the instructions below.



FAILURE TO PROPERLY LIFT AND SECURE TRAILER AND SUSPENSION MAY CAUSE PERSONAL INJURY OR DEATH.

1. Once the trailer is properly lifted and secured place a jack stand or block under the axles near the ends to be repaired. These rests are only to support the axles and suspension and will remove the load from them. They do not support the trailer.
2. Remove the u-bolt nuts and disassemble the u-bolts and tie plates from the axle.
3. Remove the eye bolts from the spring and slide the spring out.
4. If only the eye bushings are to be replaced use either a c-clamp or vice to press the worn bushing out.
5. Installation of the new bushing is the reverse of removal.
6. Installation of the spring is the reverse of removal. See torque specification on page 22 for component requirements.



Equalizer Replacement

To remove the equalizer bar or any equalizer bar component please refer to the instructions below.



FAILURE TO PROPERLY LIFT AND SECURE TRAILER AND SUSPENSION MAY CAUSE PERSONAL INJURY OR DEATH.

1. Once the trailer is properly lifted and secured place a jack stand or block under the axles near the ends to be repaired. These rests are only to support the axles and suspension and will remove the load from them. They do not support the trailer.
2. Remove the spring eye bolts and equalizer bolts.
3. Remove the equalizer bar.
4. If only replacing the equalizer bushings use either a c-clamp or vice to press the worn bushings out.
5. Installation of the new bushing is the reverse of removal.
6. Installation of the equalizer is the reverse of removal. The equalizer bolt utilizes a lock nut which should be replaced. See torque specification on page 22 for component requirements.



Wheels & Tires

Torque values on lug nuts are required and adhering to the proper torque values and schedule is of the utmost importance. Also of extreme importance is the selection of the proper wheel mounting pilot diameter on hub piloted wheels.

1. Mount wheels
2. Start all nuts by hand to prevent cross threading and other damage.
3. After all lug nuts have been "snugged", tighten the nuts to the recommended torques using patterns shown on the following pages and in the stages below. Take note to select the proper mounting type.
4. Nuts should be tightened in stages of 20% of final torque, 50%, and 100%.
5. Check and re-torque nuts after 25, 50 miles, and then periodically.

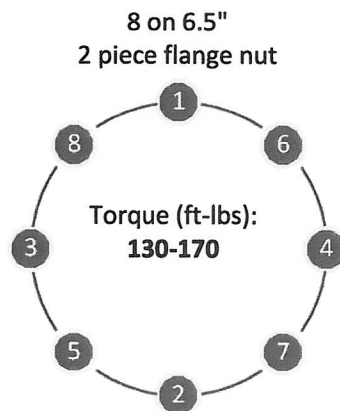
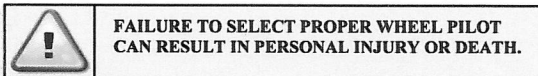
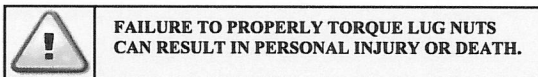

Standard 10K-12K system

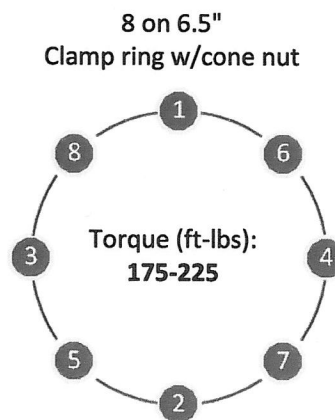

Optional 10K-12K system

8 on 275mm
2 piece flange nut

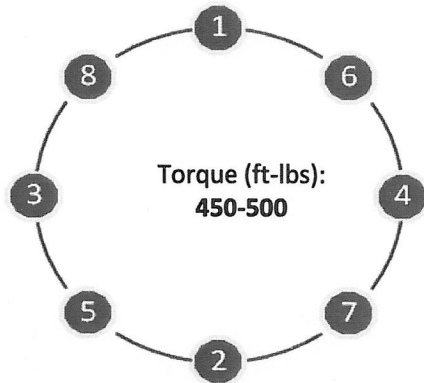

Available 16K system

10 on 8.75"
2 piece flange nut

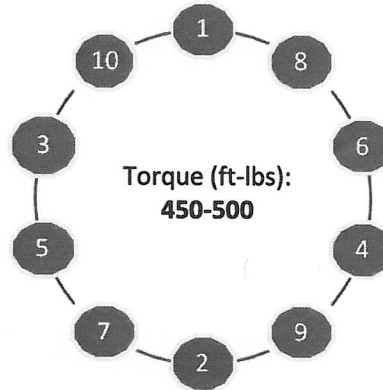

Available 16K system

Storage & Infrequent Use

Prolonged or even short term storage can affect multiple wear items on the trailer. The most common items affected are seals, bearings, and tires.

Oil bath axles need to be moved in order allow the oil to fully lubricate the bearings. It is highly recommended that the hubs be rolled at least once every two weeks to prevent oil pooling and oxidation on the bearings.

Storage Preparation

1. Follow the trailer manufacturer's guidelines for lifting and supporting the trailer in order to remove the load from the trailer tires. Do not place supports on axle beams.
2. If axle has been immersed in water, remove the hubs clean and lubricate bearings and re-install.

After Storage

3. Inspect the suspension system, for worn bushings and loose bolts.
4. Remove drums and check for wear and remove any oxidation with emery cloth.
5. Inspect brake assembly for cracked linings, worn magnets, free movement of parts, and oxidation. Clean and replace as necessary.
6. Remove seal and inspect bearings and races.
7. Replace seal and complete re-assembly of drum
8. Mount and torque wheels per specifications.

Torque Requirements



Item	Size	Torque (ft-lbs)
U-bolt-10K	5/8"-11	90-110
U-bolt-12K & 16K	3/4"-10	130-170
Spring Eye Bolt	3/4"-16	0-1/16" End Play
Equalizer Bolt-10K	1"-8	0-1/16" End Play
Equalizer Bolt-12K & 16K	1 1/8"- 7	0-1/16" End Play
Plastic Cap	3 3/4"-8	20-30
Torsion Mounting Bolts	1/2"-13	90-110
Brake Nuts	1/2"-20	70-100
Lug Nuts	See Wheels & Tires	

Oil & Grease Specifications

Grease

Specification	Characteristic
NLGI Grade Number	2
NLGI Certified, ASTM D 4950	GC-LB
Dropping Point (ASTM D 2265)	500 °F
Color	Blue/Red
Thickener	Lithium Complex
Viscosity Index	80
Additives	EP/Anti-wear, Rust and Oxidation Inhibited

Common Sources	
CITGO	Lithium Complex Grease, EP No. 2
Mystik Oil Company, Inc.	JT-6 HI-TEMP Grease No. 2
Exxon Mobil	Mobil 1 Synthetic Grease
Conoco Phillips	Multiplex Red No. 2
Pennzoil	Premium Wheel Bearing Grease 707L Red
Valvoline (Ashland, inc.)	Multi-Purpose Grease GM (General Motors)

Note: DO NOT mix anhydrous calcium based grease with lithium based grease.

Oil

Specification	Characteristic
SAE Grade Number	90
Flash Point, ASTM D 92	400 °F
Color	Red/Amber
Viscosity Index, ASTM D 2270	115
API Service Classification	GL-4

Common Sources	
CITGO	CITGEAR Standard XD
H&B Industries	HB-1160 Starfilm EP Gear lube
Mystik Oil Company, Inc.	Mystik Power Lubricants
Mystik Oil Company, Inc.	JT-7 Multi Purpose
Pennzoil	GEARPLUS SAE 80w-90 GL-4
Shell	Spirax GX

Note: DO NOT mix synthetic and non-synthetic oils.

Parts Lists**10K**

A	U-BOLT	UB95BZPS
B	SPRING	8131
C	LOCK WASHER	58LW
D	U-BOLT PLATE	10625BZPN
E	HEX NUT	58HN

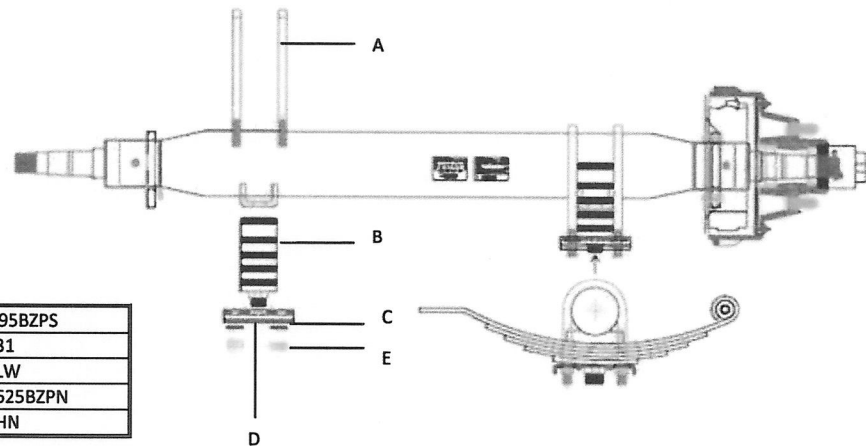

10K Continued

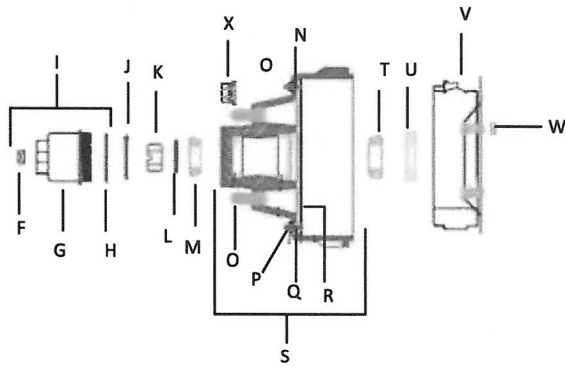

F	OIL CAP PLUG	RP-200
G	CAP	12011 (OIL) 1201G (GREASE)
H	O-RING	V75340
I	OIL CAP ASSEMBLY	12011-1
J	COTTER PIN	CP-3
K	SPINDLE NUT	4797
L	SPINDLE WASHER	4798
M	OUTER BEARING	25580
N	DRUM	9986B-1P (4.88) 99865-1P475 (4.75)
O	WHEEL STUD	4738-28
P	LOCK NUT	14LN
Q	ARMATURE BOLT	FL14201
R	ARMATURE PLATE	10KARM
S	DRUM ASSEMBLY	99865-1PA (4.88) 99865-1P475A (4.75)
T	INNER BEARING	28580
U	OIL SEAL	CR27438 (OIL) OB27377 (GREASE)
V	BRAKE ASSEMBLY	4738-L/R
W	BRAKE NUT	12LN
X	LUG NUT	568216

12K

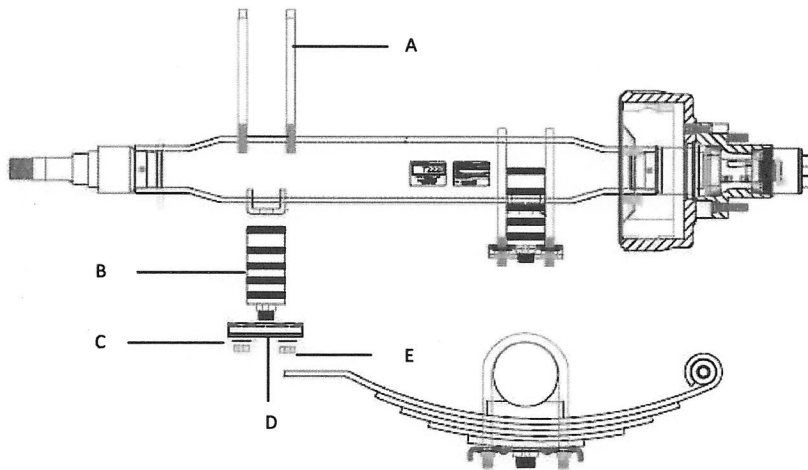

A	U-BOLT	UB121625BZPL
B	SPRING	8132
C	LOCK WASHER	34LW
D	U-BOLT PLATE	121625BZPN
E	HEX NUT	34HN

12K Continued

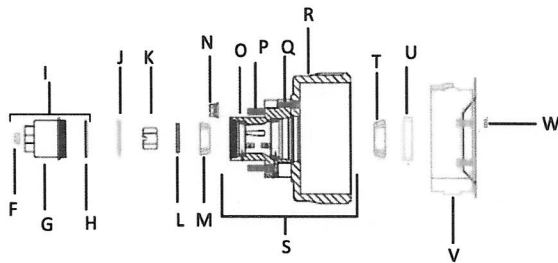

F	OIL CAP PLUG	RP-200
G	CAP	12011 (OIL) 1201G (GREASE)
H	O-RING	V75340
I	OIL CAP ASSEMBLY	12011-1
J	COTTER PIN	CP-3
K	SPINDLE NUT	47127
L	SPINDLE WASHER	47128
M	OUTER BEARING	JM205149
N	LUG NUT	568216
O	HUB	812865-1
P	WHEEL STUD	4738-28
Q	ATTACHING BOLT	1215BOLT
R	DRUM	912865-1-DRUM
S	DRUM ASSEMBLY	912865-1(4.88) 912865-1475 (4.75)
T	INNER BEARING	39590
U	OIL SEAL	CR31281 (OIL/GREASE) OB3145059 (OIL/GREASE)
V	BRAKE ASSEMBLY	4741-L/R
W	BRAKE NUT	12LN

16k

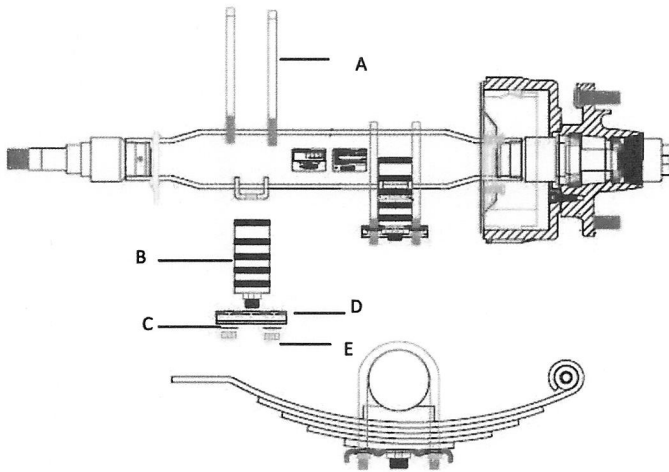

A	U-BOLT	UB121625BZPL
B	SPRING	093182-14
C	LOCK WASHER	34LW
D	U-BOLT PLATE	121625BZPN
E	HEX NUT	34HN

16K Continued

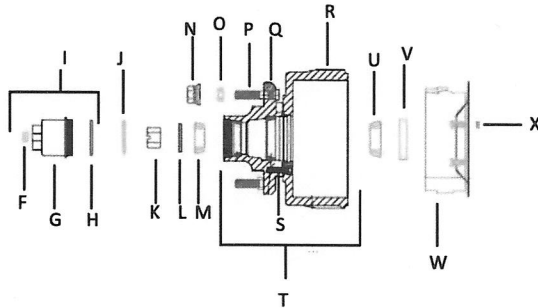

F	OIL CAP PLUG	RP-200
G	CAP	12011 (OIL)
H	O-RING	V75340
I	OIL CAP ASSEMBLY	12011-1
J	COTTER PIN	CP-3
K	SPINDLE NUT	47127
L	SPINDLE WASHER	47128
M	OUTER BEARING	JM205149
N	LUG NUT	09065114
O	STUD RING	4741-10
P	WHEEL STUD	4741-34
Q	HUB	816108-1
R	DRUM	916108-1-DRUM
S	ATTACHING BOLT	1215BOLT
T	DRUM ASSEMBLY	916108-1
U	INNER BEARING	39590
V	SEAL	CR31281 (OIL/GREASE)
W	BRAKE	4741-L/R
X	BRAKE NUT	12LN

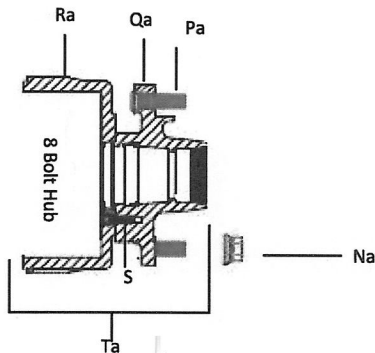

Na	LUG NUT	WN333
Pa	WHEEL STUD	4741-30
Qa	HUB	816810-1
Ra	DRUM	912865-1-DRUM
Ta	DRUM ASSEMBLY	916810-1

TROUBLESHOOTING

New trailers are those with less than 250 miles on them or less than 2 week old

BRAKING**Brakes on new trailer seem to be inoperative or weak.**

- Brakes may still be in the burnish phase if the trailer has less than 250 miles on it. Monitor braking to see if it improves with use.
- Check brake controller and trailer electrical connections for proper setup as well as for open and short circuits.
- Trailer may be overloaded. Check weight or loaded trailer. See page 7.
- Insufficient current draw by the magnet. Check electrical connections.
- Brake may need to be re-adjusted. See page 14.
- Possible lining contamination. Check brake shoes for contamination.

- Check magnet for grease or oil. Clean as needed.
- NOTE: SOME INTEGRATED BRAKE CONTROLLERS DO NOT WORK ON ALL BRAKING SYSTEMS. PLEASE SEE VEHICLE OWNER'S MANUAL FOR GUIDANCE.

Brakes on used trailer seem to be inoperative or weak.

- Insufficient current draw by the magnet. Check electrical connections for open and short circuits.
- Brake may need to be re-adjusted. See page 14.
- Possible lining contamination. Check brake shoes for contamination.
- If trailer has been stored for longer than 3 months please see section on storage, see page 21.
- Brake linings may be glazed.
- Magnets may be worn.
- Check magnet for grease or oil. Clean as needed.
- Trailer may be overloaded. Check weight or loaded trailer. See page 7.
- Tires may have a large static load radius (SLR).
- Brake drums may be worn or severely scored. See page 15

Brakes on new trailer seem to drag.

- Check brake controller, breakaway switch, and trailer electrical connections for proper setup.
- Brake may need to be re-adjusted. See page 14.
- Brake assembly may be mounted improperly. See page 11.
- Bearings may be too loose. Check bearing adjustment. See page 17.
- Drums may be out of round. Check drum run-out see page 15.
- Brake lining may have become detached.
- Brake components or other debris may be loose and lodged in drum.
- NOTE: SOME INTEGRATED BRAKE CONTROLLERS DO NOT WORK ON ALL BRAKING SYSTEMS. PLEASE SEE VEHICLE OWNER'S MANUAL FOR GUIDANCE.

Brakes on used trailer seem to drag.

- Check brake controller, breakaway switch, and trailer electrical connections for proper setup.
- Brake may need to be re-adjusted. See page 14.
- Possible lining contamination. Check brake shoes for contamination.
- Brake assembly may be mounted improperly. See page 11.
- Brake components or other debris may be loose and lodged in drum.
- Brake lining may have become detached.
- Spindle may be bent.
- Check for excessive brake dust in drum. Brake may need to be re-adjusted. See page 31.
- Check for excessive brake dust in drum. Brake may be seized. If trailer has been not been used recently. Please see section on storage, page 21.
- Check brake linings for wear pattern. See page 11.
- Check that brake components move freely. Lubricate as needed.
- Drums may be out of round. Check drum run-out. See page 15.

Brakes on new trailer squeal.

- If in a humid environment some squeal may be normal.
- Check for excessive brake dust in drum. Brake may need to be re-adjusted. See page 14.

- Check for excessive brake dust in drum. Brake may be seized; this most often occurs if trailer is several months post manufacture when purchased. Please see section on storage, page 21.
- Check brake linings for wear pattern. See page 11.
- If accompanied by dragging see Troubleshooting, **Brakes on new trailer seem to drag.**

Brakes on used trailer squeal.

- If in a humid environment some squeal may be normal.
- Check for excessive brake dust in drum. Brake may need to be re-adjusted. See page 14.
- If trailer has been stored for longer than 3 months please see section on storage, page 21.
- If accompanied by dragging see Troubleshooting, **Brakes on used trailer seem to drag.**
- Brake shoe may be bent.
- Spindle may be bent.
- Check that brake components move freely. Lubricate as needed.

Brakes on trailer seem to be warm/hot.

Brakes operate in temperature ranges in excess of 400°F. 130°F may cause burns. It is common for new trailer brakes to have 90°F temperature difference between them. Monitor this to see if it goes away.

- Verify that the source of the heat is the drum and not the hub portion of the hub/drum assembly. The drum should be hotter than the hub near the grease/oil cap.
- If this is accompanied by dragging/squealing see sections above.
- Check brake controller, breakaway switch, and trailer electrical connections for proper setup.

Brakes on new trailer lock up

- Check brake controller, breakaway switch, and trailer electrical connections for proper setup.
- Does the trailer have to roll back to release? Brake may be under-adjusted and will need to be re-adjusted. See page 14.
- Brake components or other debris may be loose and lodged in drum.
- Axle and/or brake assembly may be installed incorrectly.
- Possible lining contamination. Check brake shoes for contamination.
- Brake lining may have become detached.
- Bearings may be too loose. Check bearing adjustment. See page 17.
- Drums may be out of round. Check drum run-out. See page 15.

Brakes on used trailer lock up

- Check brake controller, breakaway switch, and trailer electrical connections for proper setup.
- Brake components or other debris may be loose and lodged in drum.
- Axle and/or brake assembly may be installed incorrectly see page 14.
- Possible lining contamination. Check brake shoes for contamination.
- Brake lining may have become detached.
- Does the trailer have to roll back to release? Brake May be under-adjusted and will need to be re-adjusted. See page 14.
- Spindle may be bent.

- Brake shoe may be bent, Check shoe lining for wear pattern. See page 11
- Drums may be out of round. Check drum run-out. See page 15.

Brakes on trailer are intermittent

- Check brake controller and trailer electrical connections for proper setup as well as for open and short circuits
- Check for broken wires near pinch points and replace.

Brakes on trailer are harsh

- Check brake controller and trailer electrical connections for proper setup.
- Brake may need to be adjusted. See page 14.

Brakes on trailer surge

- Possible lining contamination. Check brake shoes for contamination. Check magnet for grease or oil. Clean as needed.
- Drum may be out of round. See page 15.
- Check brake controller and trailer electrical connections for proper setup.

HUBS & BEARINGS**Excessive vibration when towing**

- Check tires for bulges, flat, spots, etc to rule out faulty tire or out of balance wheel.
- Often vibrations from out of round hubs peak around 50 miles per hour. If this happens check drum for visual distortions.
- Check bearing endplay. Tire tilt should be no more than .005" per inch of tire diameter. End play should be no more than .010".
- Often this is due to a broken suspension component, if none of the above applies. Check u-bolts, bushings, springs, etc.

Excessive heat from Hub/drum

Often the source is from the brake assembly. See Brakes on trailer seem to be warm/hot in the Braking section above

- Spindle nut may be too tight, adjust as needed. See page 17.
- Lack or wrong type of grease/oil.
- Check that lubricant is dark in color. Pale colored grease may be contaminated with water.

Dust caps fall off

- Improper installation. Replace
- If problem is persistent hub may be defect. Replace hub.

Persistent seal leaks

- Improper selection of or bad installation of seal. See page 16.
- Damaged hub housing.
- Damaged spindle. Spindle finish should be below 100 microns.

SUSPENSION

Rubber Bushings wear pre-maturely

- Overloaded trailer. See page 14
- Bolts holding bushings on are tightened improperly. Verify that bolts are torqued properly. See page 22.
- Hangers are welded on crooked and/or other axle mounting defect. Verify that hangers are welded onto trailer properly and springs are straight.
- Bushing housing is worn and causes bushings to be loose. Verify that holes for bushings meet manufacturer's requirements.

Cracked bushing housing

- Overloaded trailer. See page 7.
- Direct metal to metal contact with no lubricant. Replace components and follow maintenance schedule.

Failed Leaf Spring

- Loose U-bolts. Spring will fail at the center pin near between the u-bolts. See torque requirements page 22.
- Corrosion. Failure locations vary. This is most common in marine applications.
- Fatigue Failure. Shorter leaves will break first.
- Fatigue Failure. Leaf spring has started to flatten out. Replace springs.
- Material flaw. Only determinable by testing.

Failed Torsion Suspension

- Heat applied to axle tube or attaching brackets.
- Overloaded trailer. See page 7.
- Mixed start angles on tandem axle setup.
- Severe corrosion on axle beam caused by using non-galvanized axle in corrosion prone environments.
- Material Flaw. Only determinable by testing.

Sales & Service

Replacement parts for Rockwell American axles can be ordered directly from Quality Trailer Products by calling (877) 787-2453

or by visiting any of our 19 Direct Distribution Centers nationwide.



Alabama

Birmingham
960 Grants Mill Rd Irondale, Alabama 35210 Phone: (800)874-4292 Fax: (800)655-2944 Birmingham@qtrailer.com

Arizona

Phoenix
2930 West Osborn Road Phoenix, Arizona 85017 Phone: (888)999-8233 Fax: (602)271-0148 Phoenix@qtrailer.com

California

Fresno
2888 S. Orange Ave. Fresno, California 93725 Phone: (800)742-6203 Fax: (559)237-1913 Fresno@qtrailer.com

California

Montebello
1550 Gage Road Montebello, California 90640 Phone: (800)624-1715 Fax: (323)722-4177 Montebello@qtrailer.com

California

National City
1616 Precision Park Lane, Suite D San Diego, California 92173 Phone: (800)472-2202 Fax: (619)662-1696 Nationalcity@qtrailer.com

California

Sacramento
3701 Parkway Place W. Sacramento, California 95691 Phone: (800)3216362 Fax: (916)371-0228 Sacramento@qtrailer.com

Colorado

Aurora
14600 E. 35th Place-Unit B Aurora, Colorado 80011 Phone: (800)307-5944 Fax: (303)307-4774 Aurora@qtrailer.com

Florida

Plant City-Mfg
3804 Sydney Road Plant City, FL 33567 Phone: (813)659-2948 Fax: (813)659-9847 Plantcity@qtrailer.com

Indiana

Angola
1304 Wohlert St. Angola, IN. 46703 Phone: (877) 730-3748 Fax: (877) 730-6130 Angola@qtrailer.com

Missouri

Kansas City
519 Duck Road Grandview, Missouri 64030 Phone: (888)913-8500 Fax: (800)445-6058 Kansascity@qtrailer.com

Minnesota

Freeport
208 7th St. SW Freeport, Minnesota 56331 Phone: (888)325-1485 Fax: (320)836-9550 Freeport@qtrailer.com

Oklahoma

Seminole
1801 Ray Davis Blvd. Seminole, Oklahoma 74868 Phone: (800)221-7185 Fax: (800)443-2795 Seminole@qtrailer.com

Oregon	Pennsylvania	South Carolina
Wilsonville 27180 S.W. 95th Ave. Suite 3320 Wilsonville, Oregon 97070 Phone: (800)914-9116 Fax: (503)682-0520 Wilsonville@qtrailer.com	New Holland 170 Commerce Dr. New Holland, PA 17557 Phone: (800)497-0986 Fax: (717)354-7076 Newholland@qtrailer.com	Florence Hwy 76 Palmetto Ind. Park Timmonsville, South Carolina 29161 Phone: (800)238-3903 Fax: (800)207-4770 Florence@qtrailer.com
Texas	Texas	Texas
Azle 633 N.W Hwy Azle, Texas 76020 Phone: (800)242-4882 Fax: (800)889-1435 Azle@qtrailer.com	Mt. Pleasant Hwy. 67 East Mt. Pleasant, Texas 75455 Phone: (800)635-1354 Fax: (800)301-7943 Mtpleasant@qtrailer.com	Royse City Mfg. 1012 Industrial Drive Royse City, Texas 75189 Phone: (800)334-6355 Fax: (972)635-2049 Roysecity@qtrailer.com
Texas		
San Antonio 1334 S. General McMullen Dr. San Antonio, Texas 78237 Phone: (800)854-8058 Fax: (800)343-1895 Sanantonio@qtrailer.com		

Technical Support

Technical support can be obtained by contacting (877) 787-2453, AxleSupport@rockwell.com or (800) 334-6355 for advanced troubleshooting.

Warranty

Rockwell American Limited Warranty

Quality Trailer Products- extends to the original purchaser only, a limited warranty on each Rockwell American axle assembly against defects in material or workmanship for a period of two (2) years from the date of purchase.

A warranty period of five (5) years is extended to Equalizer Torsion Axle Suspensions exclusive of wear items (hubs, brakes, bearings, and seals).

To obtain warranty service, please call (800) 334-6355 and provide the following information:

- Name and mailing address of purchaser.
- Proof of date of purchase.
- Name of manufacturer of unit under which the axle was mounted.
- Year and serial number of the trailer and axle.
- Name and address of dealer whom from the unit was purchased.

